

600 Series Deadbreak

600 Series deadbreak elbows, straight receptacles, junctions, vault stretchers and accessories are used to connect equipment and cable on primary feeder and network circuits. Designs accommodate large conductors and feature bolted connections and deadfront modular construction for maximum reliability, performance and versatility.

DE-ENERGIZED connectors can be quickly and easily connected and disconnected using standard hand tools and equipment in accordance with accepted operating practices. Optional accessories allow visible external separation, by-pass, isolation, dead-ending, grounding, and testing as well as adding taps, surge arresters and circuit protection.

Hotstick operable and separable joint systems are shown on pages A16 thru A21.

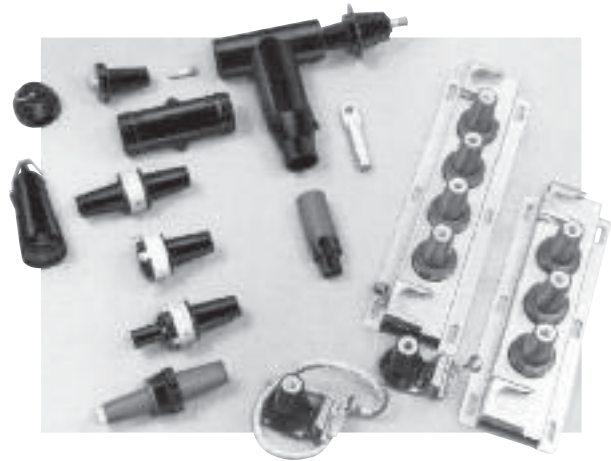

Ratings Overview

See page A3–A4 for complete information.

Current Ratings

(Prefixes: 650, K650, K655, K656, 750, 755, 756 and 03700)

600 A Continuous
25 kA sym., 10 cycles

(Prefixes 675, K675, K676, 775, 776 and 03702)

900 A Continuous
25 kA sym., 10 cycles

Note: 900 A ratings require copper cable and copper current-carrying components.

VOLTAGE RATINGS

15/25 kV Class (5 kV thru 28 kV)

16.2 kV Phase-to-Ground

28 kV Phase-to-Phase

140 kV BIL

45 kV AC Withstand

84 kV DC Withstand

21.5 kV Corona Extinction

35 kV Class

21.1 kV Phase-to-Ground

36.6 kV Phase-to-Phase

150 kV BIL

50 kV AC Withstand

103 kV DC Withstand

26 kV Corona Extinction

Note: Elastimold has increased the IEEE Standard Production and Design Test levels for 25 kV Class products to include 27 kV and 28 kV systems.

SEPARABLE CONNECTORS 600 SERIES DEADBREAK

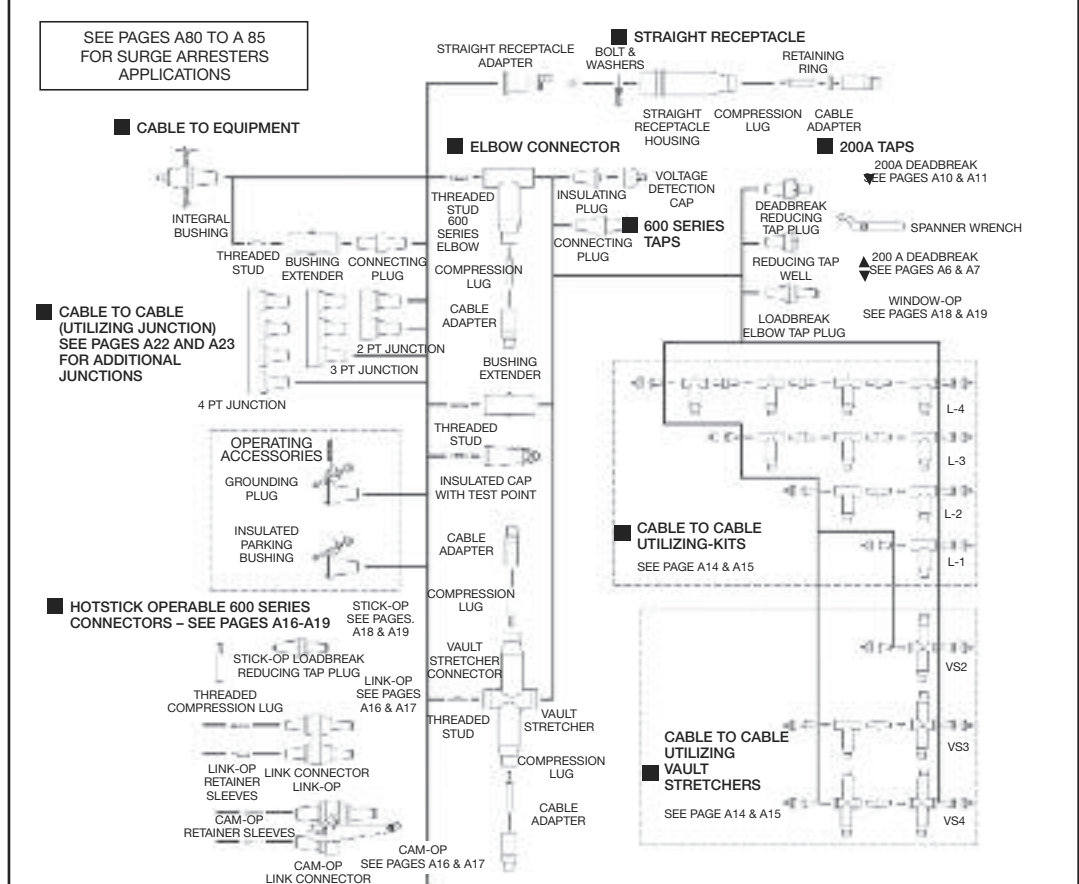

600 Series Deadbreak







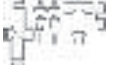

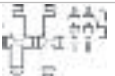

Illustration (not to scale)	Description	Voltage Class	ELASTIMOLD Cat. No.	Notes
	600 Series Elbow (w/ Insul. Plug, Cap, Stud, Lug and Cable Adapter)	15/25 kV 35 kV	K655LR-WOX Use Tables W7 and X6 755LR-WOX Use Tables W9 and X6	N1, 2, 12 N1, 2, 12
	600 Series Direct Test Elbow (w/ Insul. Plug, Cap, Stud Lug and Cable Adapter)	15/25 kV 35 kV	K655DLR-WOX 755DLR-WOX	N1, 2, 12, 14 N1, 2, 12, 14
	600 Series Elbow w/ Test Point (w/ Insul. Plug, Cap, Stud Lug and Cable Adapter)	15/25 kV 35 kV	K656LR-WOX Use Tables W7 and X6 756LR-WOX Use Tables W9 and X6	N1, 2, 12 N1, 2, 12
	600 Series Direct Test Elbow w/ Test Point (w/ Insul. Plug, Cap, Stud, Lug and Cable Adapter)	15/25 kV 35 kV	K656DLR-WOX Use Tables W7 and X6 756DLR-WOX Use Tables W9 and X6	N1, 2, 12, 14 N1, 2, 12, 14
	600 Series Elbow Housing only (w/ Stud)	15/25 kV 35 kV	K655BLR 755BLR	N1, 3 N1, 3
	600 Series Elbow w/ Test Point Housing only (w/ Stud)	15/25 kV 35 kV	K656BLR 756BLR	N1, 3 N1, 3
	600 Series Replacement Elbow Housing only w/o Test Point	15/25 kV	K655BRLR	N16
	600 Series Replacement Elbow Housing only w/o Test Point	15/25 kV	K656BRLR	N16
	600 Series Straight Receptacle (w/ Cable Adapter, Lug and Retaining Ring)	15/25 kV	K655SR-WOX Use Tables W7 and X6	N1, 2, 11
	600 Series Direct Test Straight Receptacle Elbow	15/25 kV	K655DSR-WOX Use Tables W7 and X6	N1, 2, 11, 14
	600 Series Straight Receptacle Housing (Lug and Cable Adapter not included)	15/25 kV	K655BSR	N1, 11
	Straight Receptacle Adapter	15/25 kV	K650SRA	N1, 4
	600 Series Vault Stretcher (Housing only)	15/25 kV 35 kV	K655BVS 755BVS	N1, 9 N1, 9
	Cable Size Adapter	15/25 kV 35 kV	655CA-W Use Table W7 755CA-W Use Table W9	
	Compression Lug	ALL ALL	03700X Use Table X6 03702X Use Table X6	N5 N6
	600 Series Elbow and Vault Stretcher Size Sensitive Kit (Cable Adapter and Lug)	15/25 kV 35 kV	655CK-WOX Use Tables W7 and X6 755CK-WOX Use Tables W9 and X6	N2 N2
	Adapter Retaining Ring	ALL	650ARR-X Use Table X6	

Refer to the W and X tables on pages A39 to A41 for sizing to cable insulation diameter and conductor size. For cable shield adapters and jacket seals, see page A30.

Illustration (not to scale)	Description	Voltage Class	ELASTIMOLD Cat. No.	Notes
	600 Series Straight Receptacle Size Sensitive Kit (Cable Adapter, Retaining Ring and Lug)	15/25 kV	655CK-WOX-ARR Use Tables W7 and X6	N2
	Bushing Extender (w/ Stud)	15/25 kV 35 kV	K655BE 755BE	N1, 3 N1, 3
	Insulated Cap w/ Test Point (w/ Stud)	15/25 kV	K656DR	N3, 7
	Insulated Cap w/ Test Point (w/ Stud and Ground)	15/25 kV	K656DRG	N3, 7
	Insulating Plug (w/ Cap)	15/25 kV 35 kV	K650BIP 750BIP	N1, 7, 8 N1, 7, 8
	Grounding Plug (Ground Lead 2/0 AWG x 30 in.)	15/25 kV 35 kV	650GP 750GP	N1, 7, 8 N1, 7, 8
	Insulated Parking Bushing	15/25 kV 35 kV	K650SOP 750SOP	N7, 8 N7, 8
	Connecting Plug	15/25 kV 15/25 kV 35 kV	K650CP K651CP 750CP	N1, 7, 8, 9, 13 N1, 7, 8, 10 N1, 7, 8, 10
	Deadbreak Reducing Tap Plug	15/25 kV	K650RTP	N1, 7, 8, 9
	Reducing Tap Well	15/25 kV	K650RTW	N1, 7, 8, 9
	Loadbreak Elbow Tap Plug	15 kV 25 kV 35 kV	650ETP K650ETP 750ETP	N1, 7, 8, 10, 12 N1, 7, 8, 10, 12 N1, 7, 8, 10, 12
	Vault Stretcher Threaded Stud	15/25 kV 35 kV	650VSA 750VSA	N1 N1
	600 Series Elbow Threaded Stud	15/25 kV 35 kV	650SA 750SA	N1 N1
	Assembly Tool (Window-Op)	ALL	600ATM	N12
	Spanner Wrench	ALL	600SW	N9
	Direct Voltage Test Meter Adapter for: HD Electric Meters		200TC-1	N14
	Ross Meters	ALL	200TC-2	N14
	Chance Meters		200TC-4	N14

- N1. For 900 A ratings, substitute 675 for 650 and 655; 676 for 656; K671 for K651; K675 for K650 and K655; K676 for K656; 775 for 750 and 755; 776 for 756 and 2X for 0X in the Cat. No. The 900 A rating requires copper current-carrying connector components and copper conductor cable.
- N2. Add suffix symbol from page A29 to include cable shield grounding kit and/or cable jacket sealing kit.
- N3. Available without the stud by adding "N" to the Cat. No.
- N4. Straight Receptacle Adapter is used to connect Straight Receptacles K655YBSR and K655YSR-WOX (Page A19) to equipment bushings.
- N5. Aluminum lug for use on aluminum or copper conductors. DO NOT substitute threaded 03600X lug.
- N6. Copper lug for use on COPPER CONDUCTOR ONLY. DO NOT substitute threaded 03602X lug.
- N7. Available with the stud factory-assembled by adding "SP" to the Cat. No. 675ETP, K675ETP and 775ETP are available as -SP only. The stud is not field removable.
- N8. Available with a loose stud by adding suffix "S" to the Cat. No.
- N9. 600SW spanner wrench is recommended for installation of K650CP connecting plug, deadbreak reducing tap plugs and reducing tap wells.
- N10. Use 600ATM Assembly Tool.
- N11. 600 Series Elbows and Straight Receptacles with IEEE Std. 386 capacitive test points are available by substituting 656 for 655; K656 for K655; K676 for K675; 756 for 755; 676 for 675; K676 for K675 and 776 for 775 in the Cat. No.
- N12. See page A17 for Window-Op Connector Kit.
- N13. Superseded by K651CP.
- N14. Direct Test Connectors, along with a 200TC-X series meter adapter, a properly rated voltage meter and Hot-line Stick; provides a means for direct conductor voltage testing.
- N15. With stainless steel bracket.
- N16. Replacement Elbow includes an I-Adapter, and Straight Receptacle, resulting in a net gain of 20 in.

600 Series Deadbreak

Illustration (not to scale)	Description	Voltage Class	ELASTIMOLD Cat. No.	Notes
	2-Point Junction	15/25 kV 35 kV	K650J2 750J2	N1, 9, 10 N1, 9, 10
	3-Point Junction	15/25 kV 35 kV	K650J3 750J3	N1, 9, 10 N1, 9, 10
	4-Point Junction	15/25 kV 35 kV	K650J4 750J4	N1, 9, 10 N1, 9, 10
	1-way L-Kit	15/25 kV 35 kV	K655L1 755L1	N1, 2, 3, 4 N1, 2, 3, 4
	2-way L-Kit	15/25 kV 35 kV	K655L2 755L2	N1, 2, 3, 4, 5, 6, 7 N1, 2, 3, 4, 5, 6, 7
	2-way VS-Kit	15/25 kV 35 kV	K655VSL2 755VSL2	N1, 2, 3 N1, 2, 3
	3-way L-Kit	15/25 kV 35 kV	K655L3 755L3	N1, 2, 3, 4, 5 N1, 2, 3, 4, 5
	3-Way VS Kit	15/25 kV 35 kV	K655VSL3 755VSL3	N1, 2, 3, 5, 6, 7 N1, 2, 3, 5, 6, 7
	4-Way L-Kit	15/25 kV 35 kV	K655L4 755L4	N1, 2, 3, 4, 5 N1, 2, 3, 4, 5
	4-Way VS-Kit	15/25 kV 35 kV	K655VSL4 755VSL4	N1, 2, 3, 5 N1, 2, 3, 5
	Assembly Tool (Window-Op)	ALL	600ATM	N8
	Spanner Wrench	ALL	600SW	N2

- N1. For 900 A ratings, substitute 675 for 650 and 655; 676 for 656; K675 for K650 and K655; K676 for K656; 775 for 750 and 755; 776 for 756 and 2X for OX in the Cat. No. The 900 A rating requires copper current-carrying connector components and copper conductor cable.
- N2. 600SW spanner wrench is recommended for installation of K650CP connecting plug, deadbreak reducing tap plugs and reducing tap wells.
- N3. L-Kits and VS-Kits do not include cable adapters or compression lugs. These items must be ordered separately.
- N4. 600 Series Elbows and Straight Receptacles with IEEE Std. 386 capacitive test points are available by substituting 656 for 655; K656 for K655; K676 for K675; 756 for 755; 676 for 675; K676 for K675 and 776 for 775 in the Cat. No.
- N5. 600ATM is recommended for installing K651CP and 750CP.
- N6. Can be used as a repair joint. (Gains 3-1/2 in. of repair length)
- N7. Can be used as a reducing joint for different size cables.
- N8. See page A17 for Window-Op Connector Kit.
- N9. Rubber junction with stainless steel mounting plate and back plate.
Add "-U" for rubber junction with stainless steel mounting plate, back plate and adjustable mounting bracket.
Add "-4" for rubber junction only.
Add "-5" for rubber junction, stainless steel U-straps and back plate.
- N10. Two - six-position multi-point junctions shown on pages A20 and A21.



VAULT STRETCHER

Provides an alternate method of splicing and joining various types and styles of cables using standard 600 Series components.

Refer to the W and X tables on pages A39 to A41 for sizing to cable insulation diameter and conductor size. For cable shield adapters and jacket seals, see page A30.